

All rights reserved, Copyright Kradex 2022		
Product model	Enclosure ZP240.190.60 TM - Assembly	
Format: A3	Material: PC, ABS	
Scale 1:2	Tolerance: +/- 0.5	

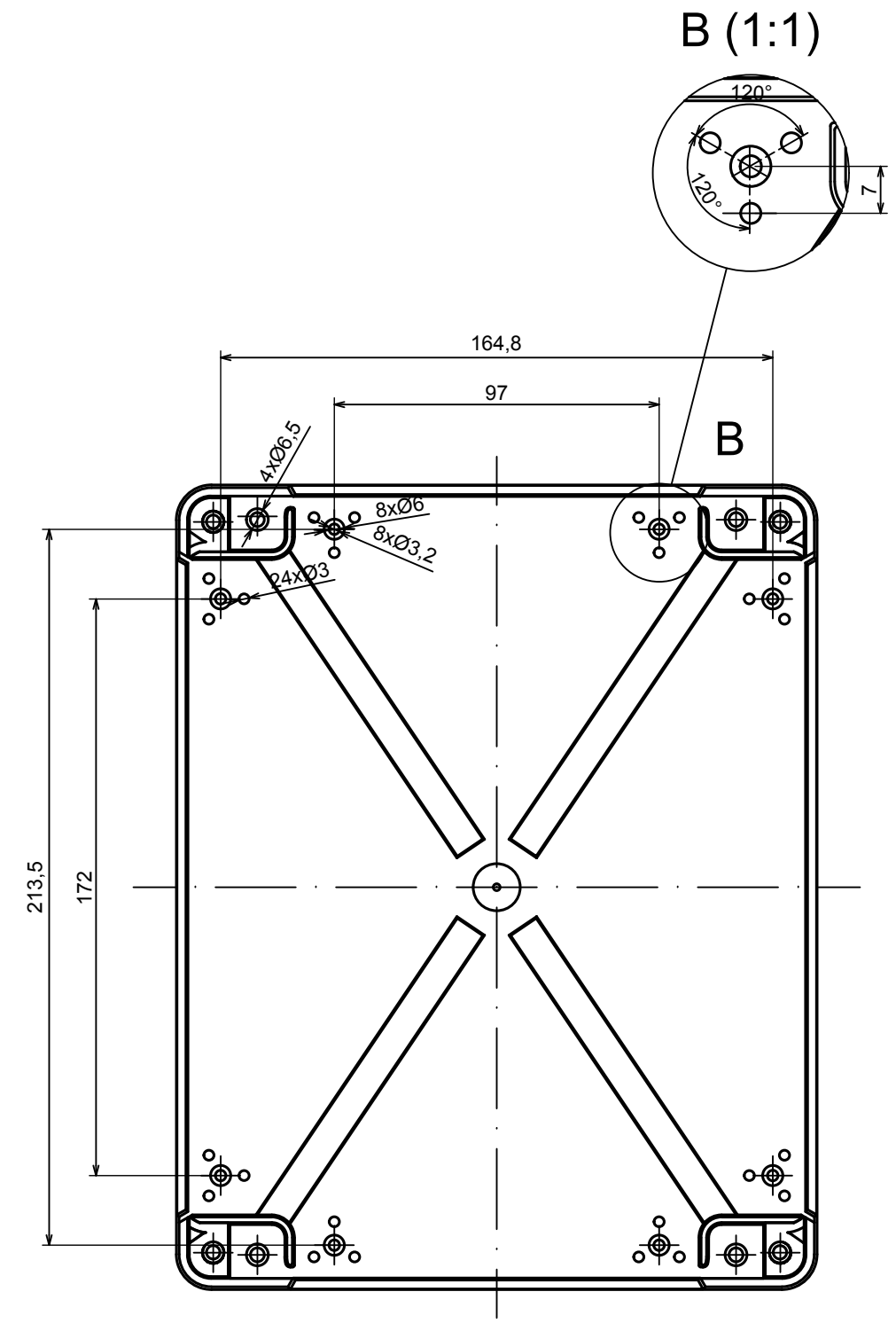
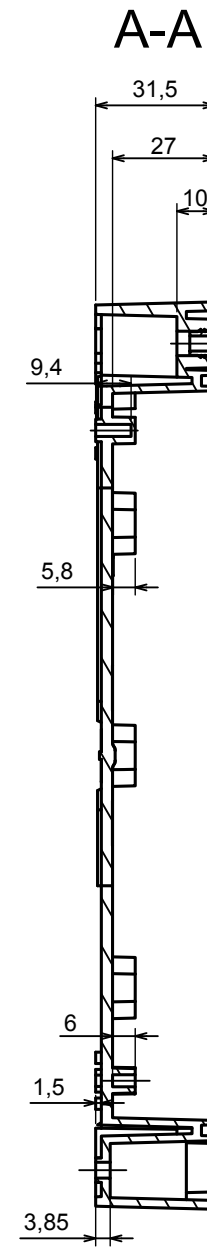
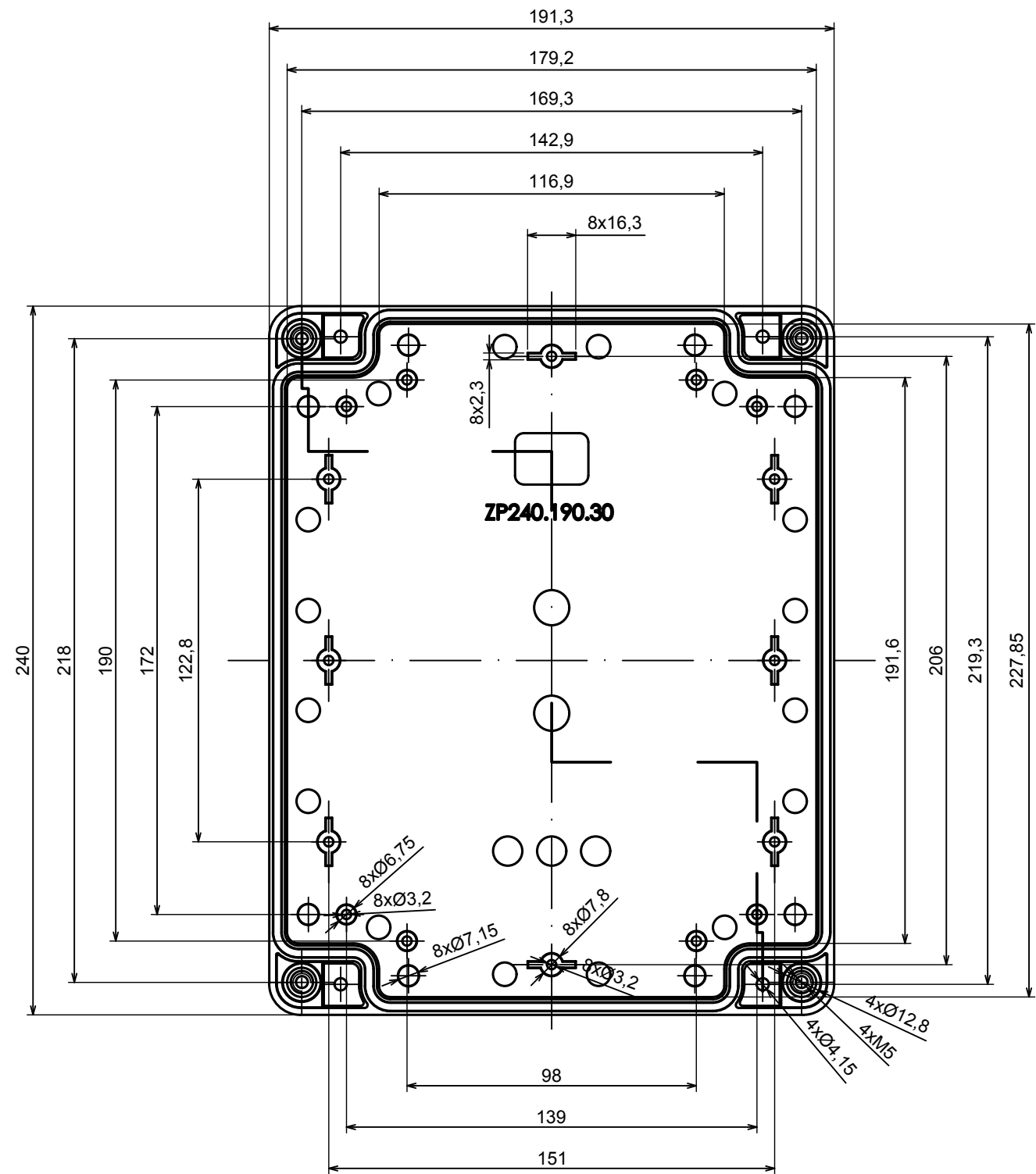

All rights reserved, Copyright Kradox 2022

Product model: Enclosure ZP240.190.60 TM - ZP240.190.30 TM Base

Format: A3 Material: PC, ABS

Scale 1:2 Tolerance: +/- 0.5



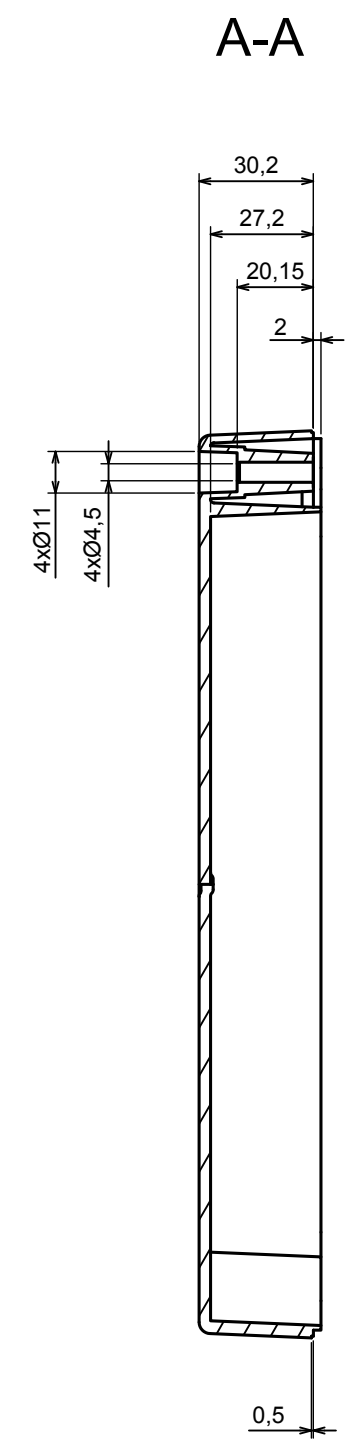
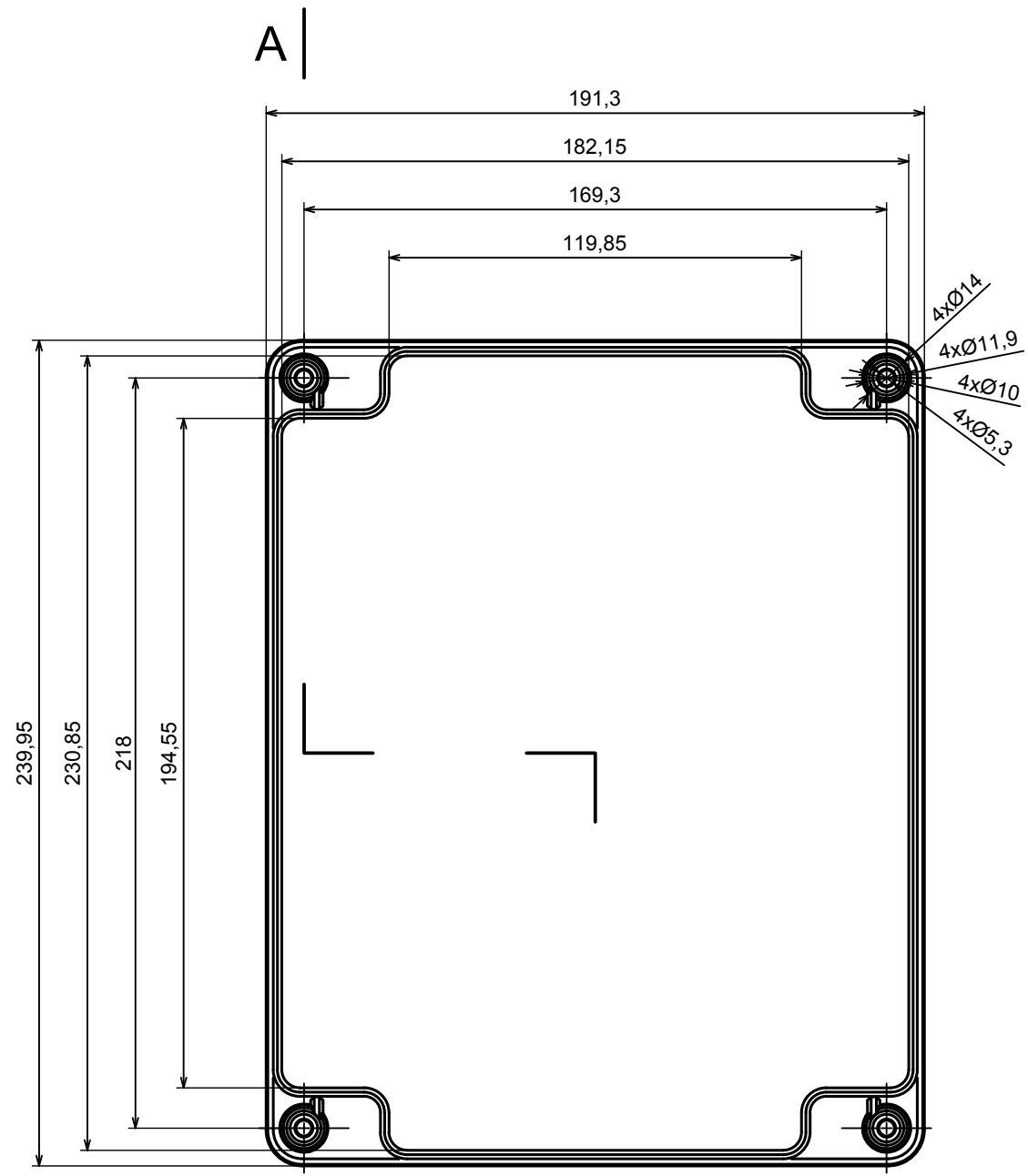

A |

All rights reserved, Copyright Kradox 2022		
Product model	Enclosure ZP240.190.60 TM - ZP240.190.30 Cover	
Format: A3	Material: PC, ABS	
Scale 1:2	Tolerance: +/- 0.5	