

A |

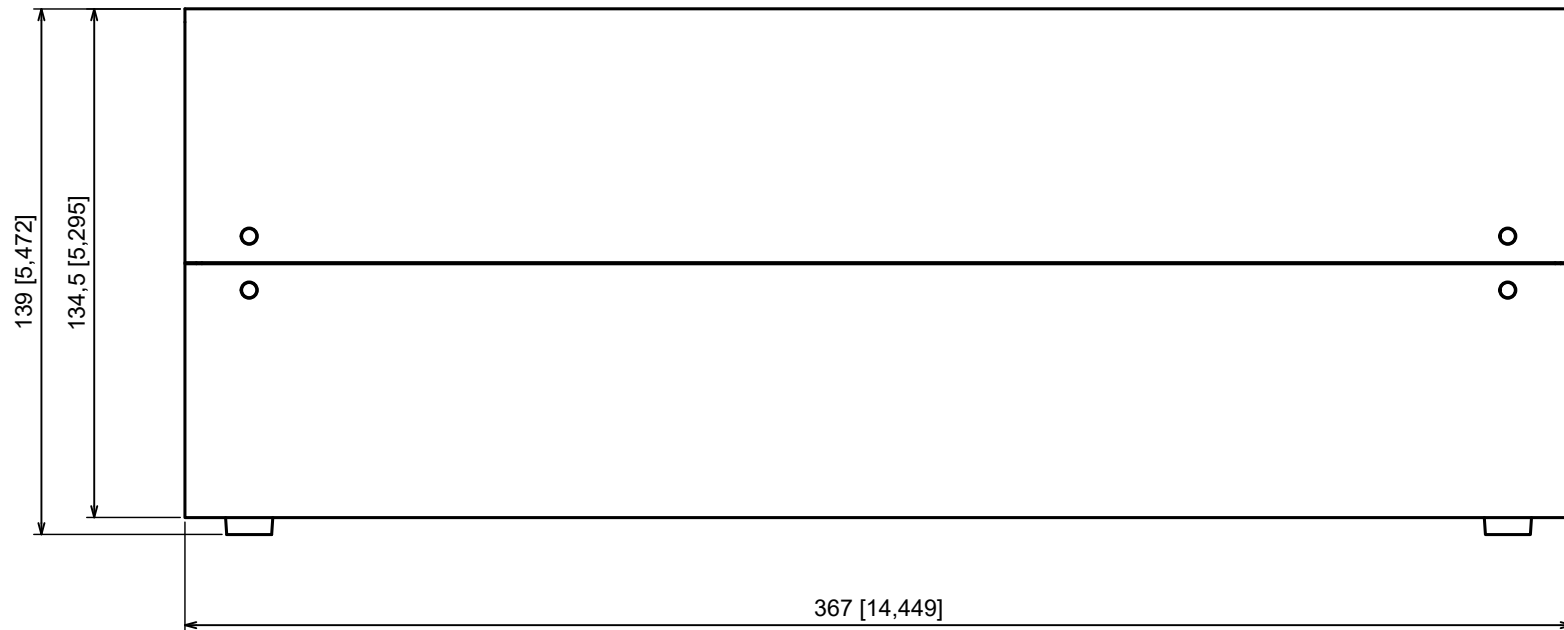

A |

A-A

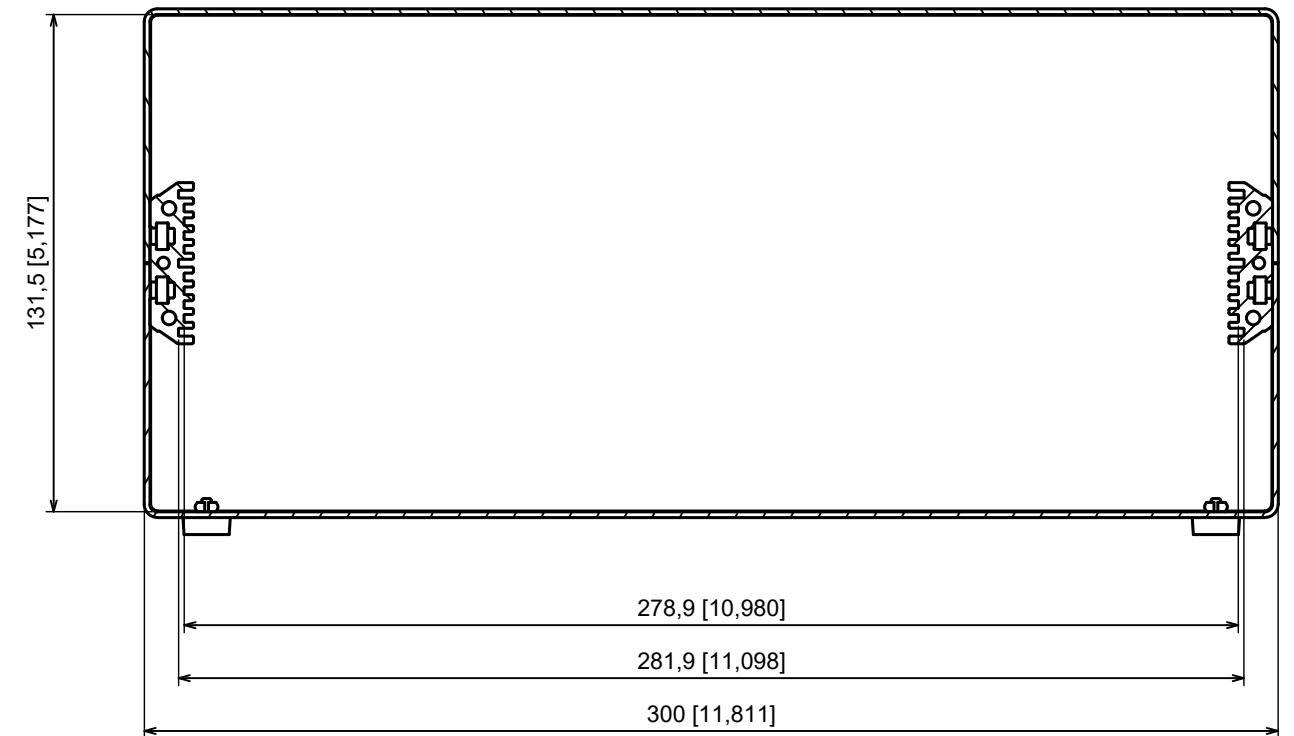

All rights reserved, Copyright Kradox 2023

Product model Enclosure ZR367.300.134 - Assembly

Format: A3 Material: Al

Scale 1:2 Tolerance: +/- 0.5



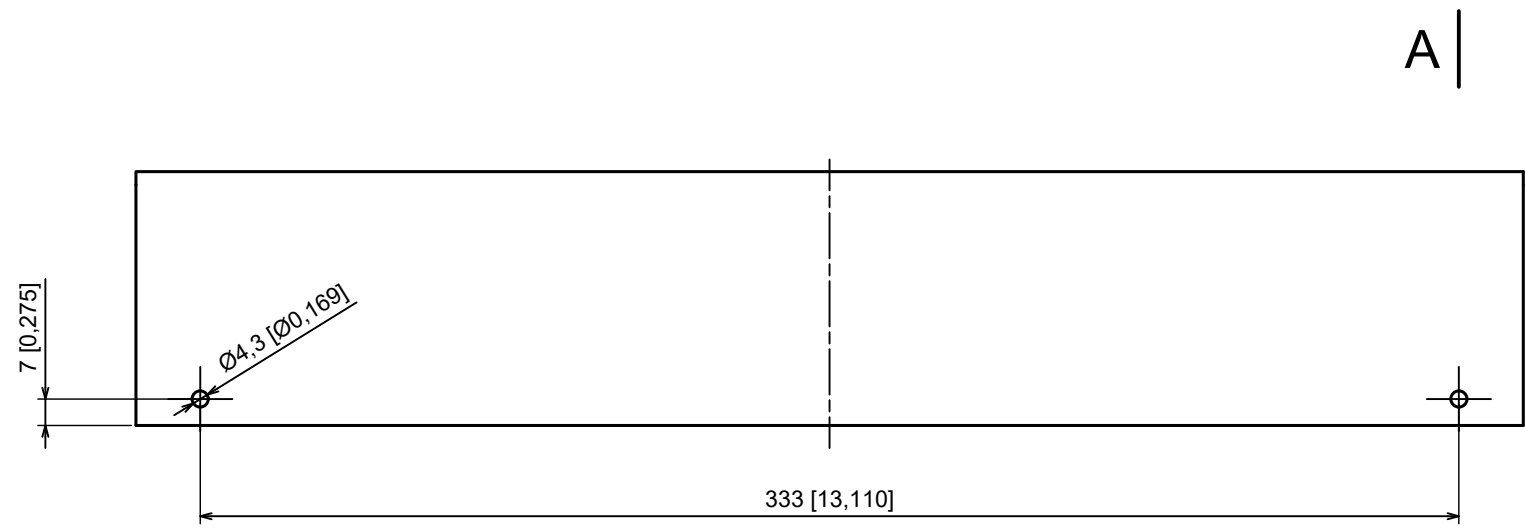
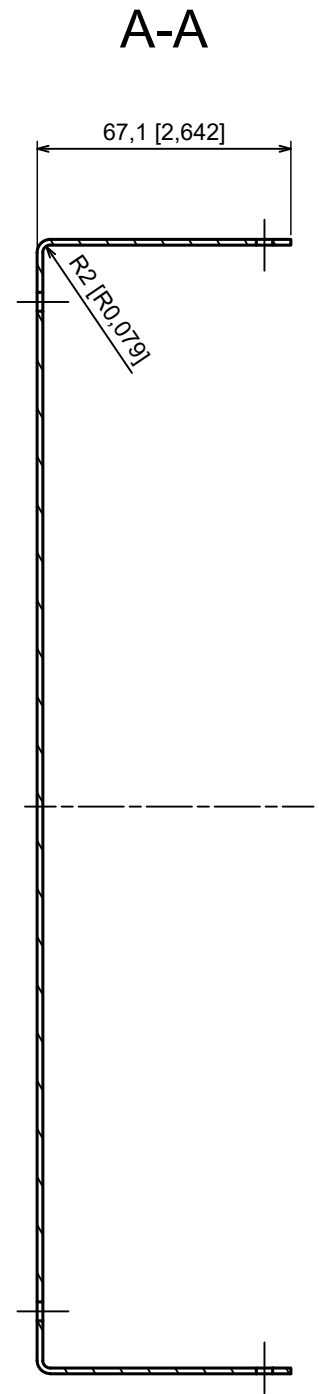
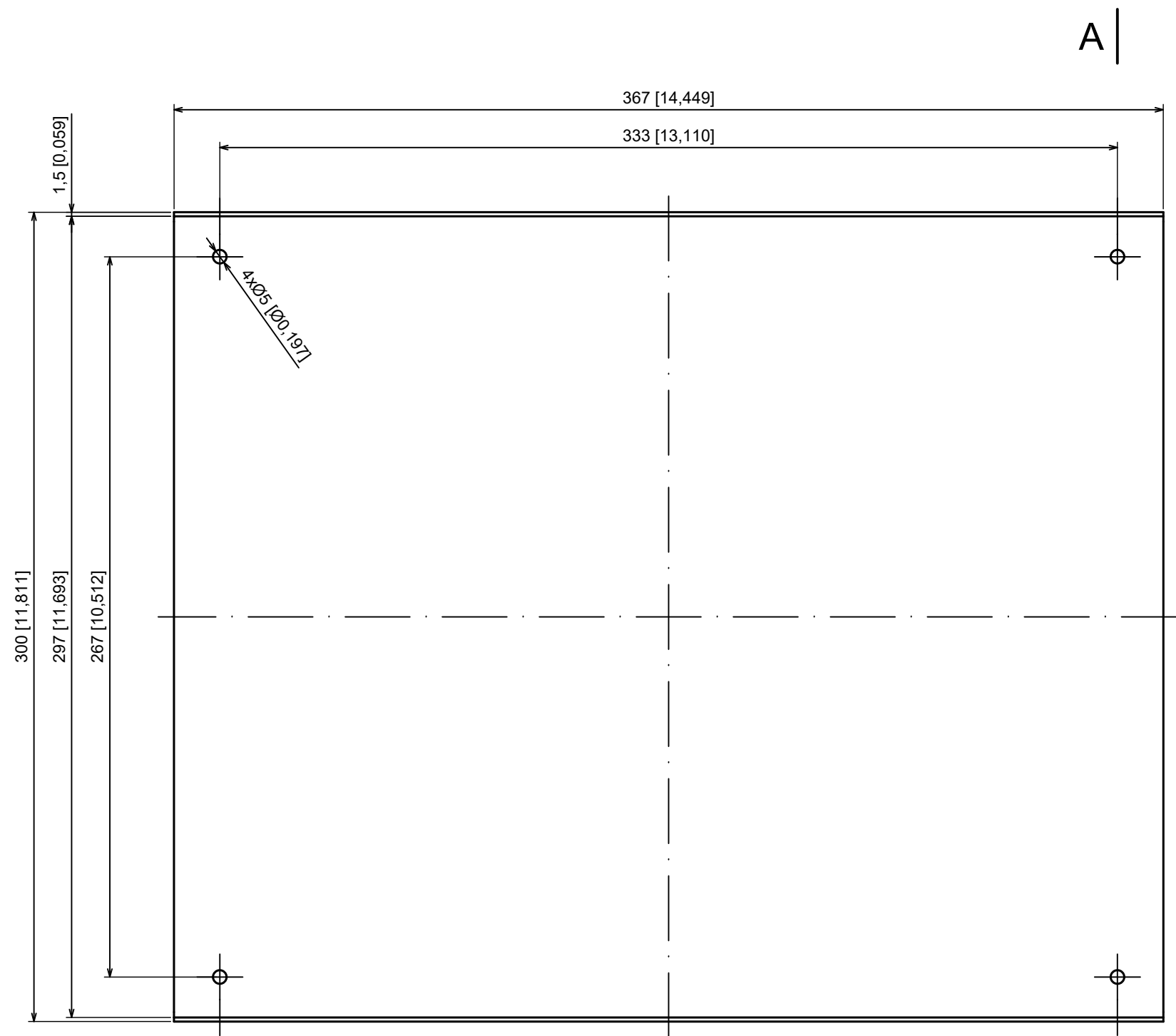

All rights reserved, Copyright Kradox 2023		
Product model	Enclosure ZR367.300.134 - Base	
Format: A3	Material: Al	
Scale 1:2	Tolerance: +/- 0.5	

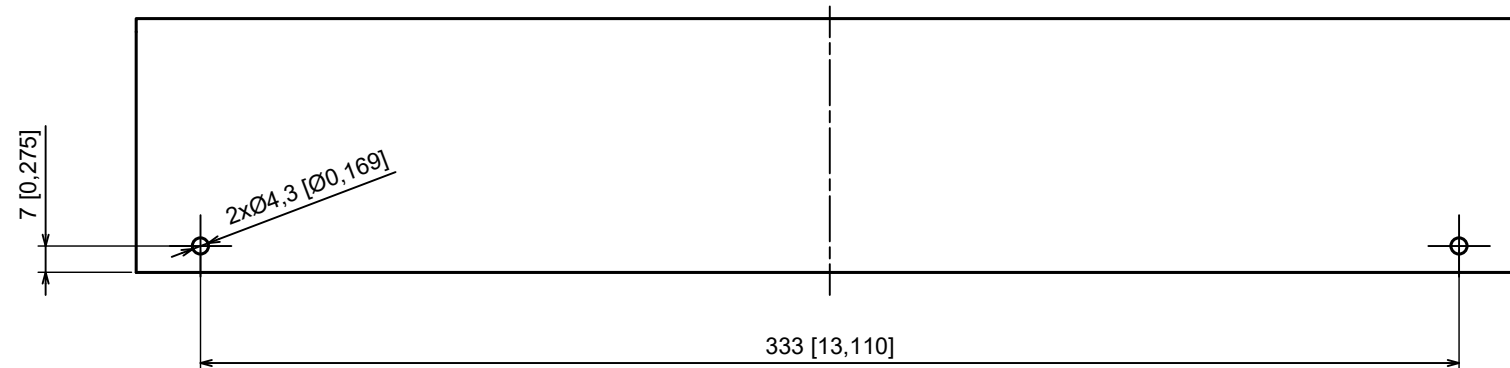
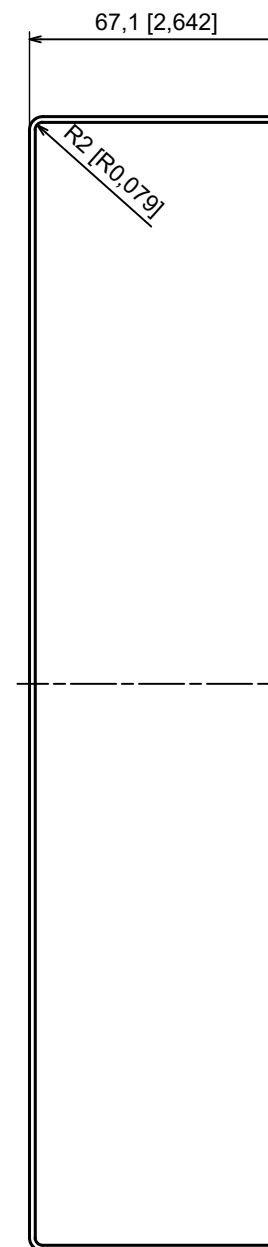
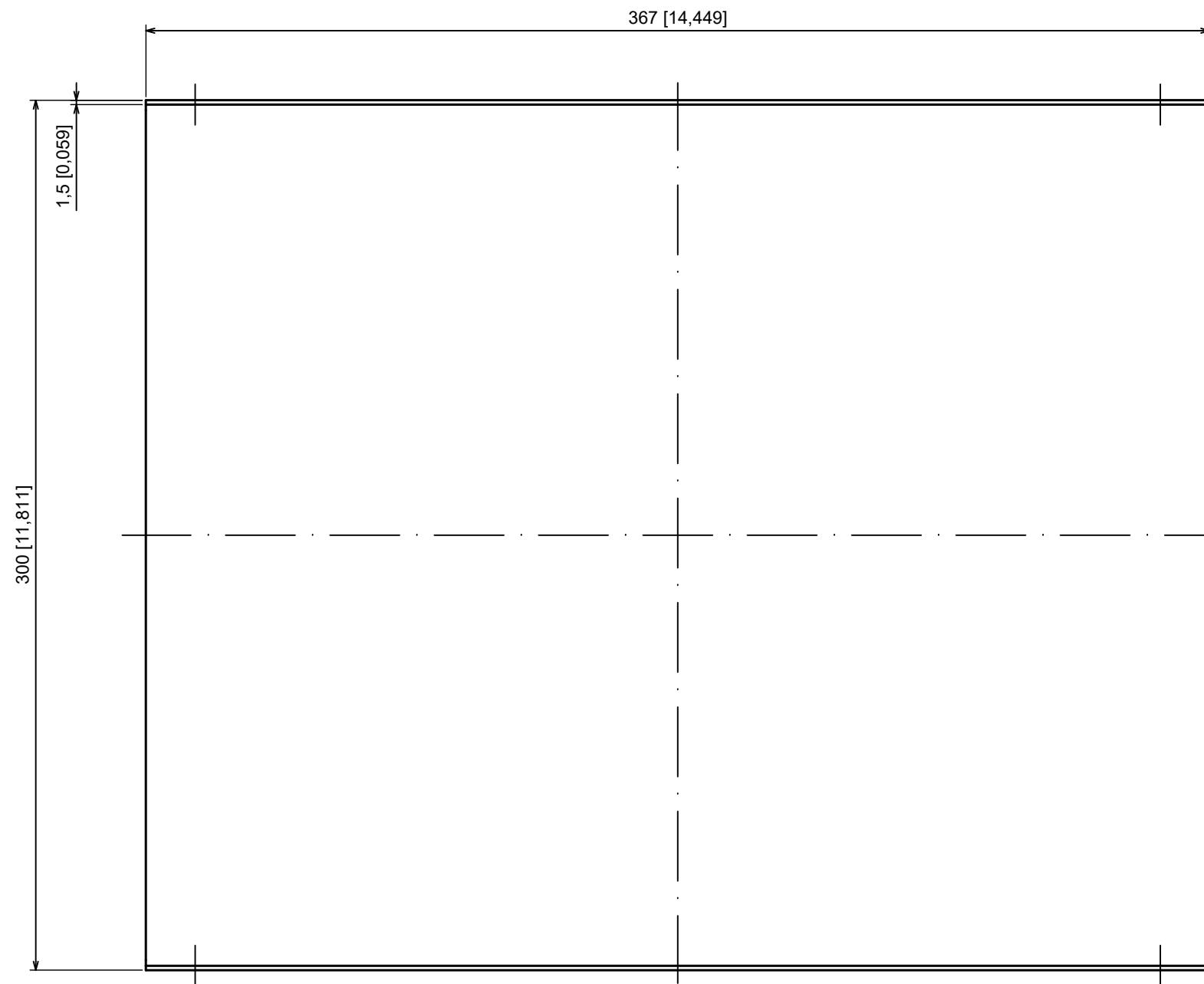

All rights reserved, Copyright Kradox 2023

Product model	Enclosure ZR367.300.134 - Cover
---------------	---------------------------------

Format: A3	Material: Al
------------	--------------

Scale 1:2	Tolerance: +/- 0.5
-----------	--------------------



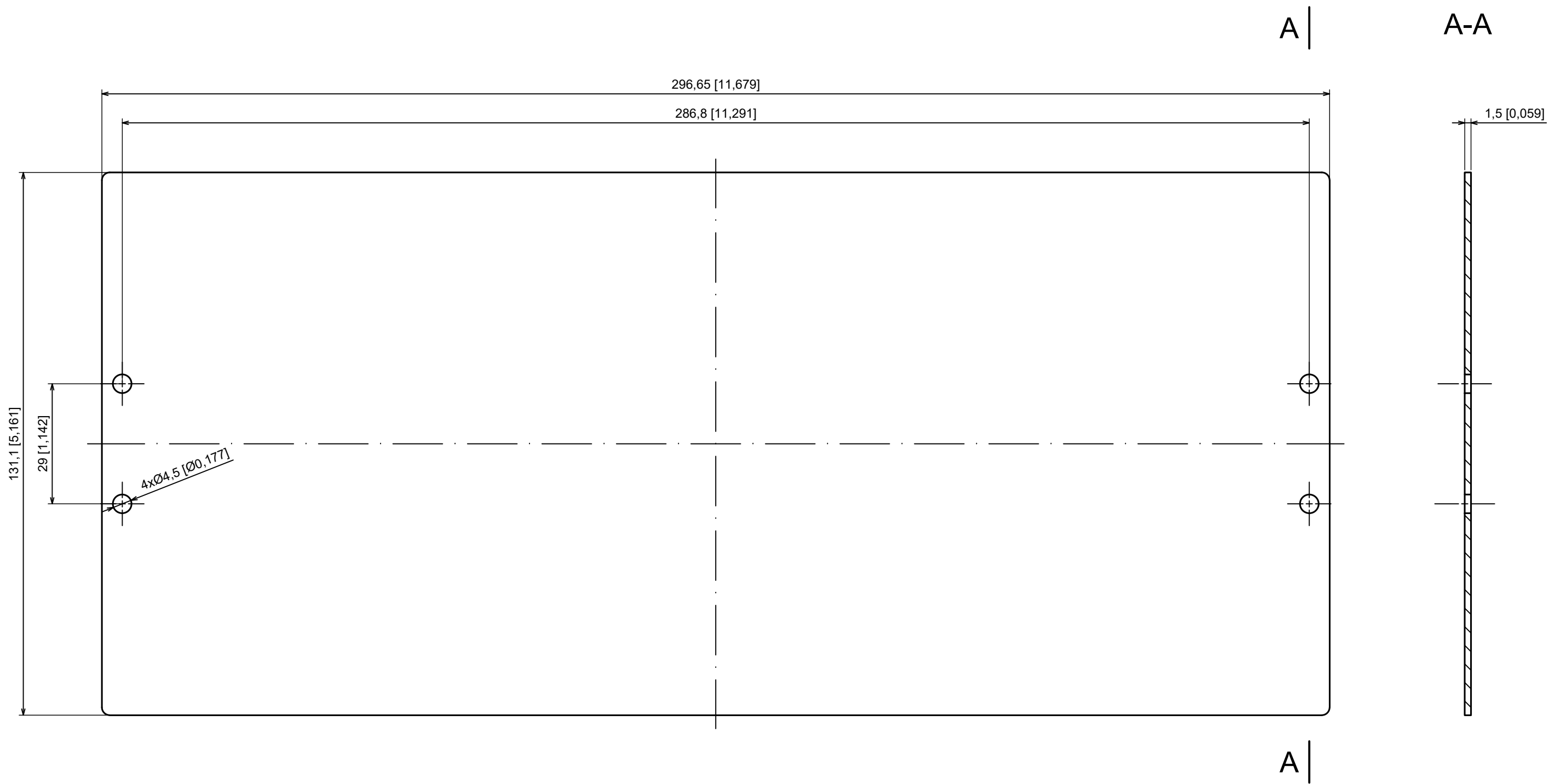

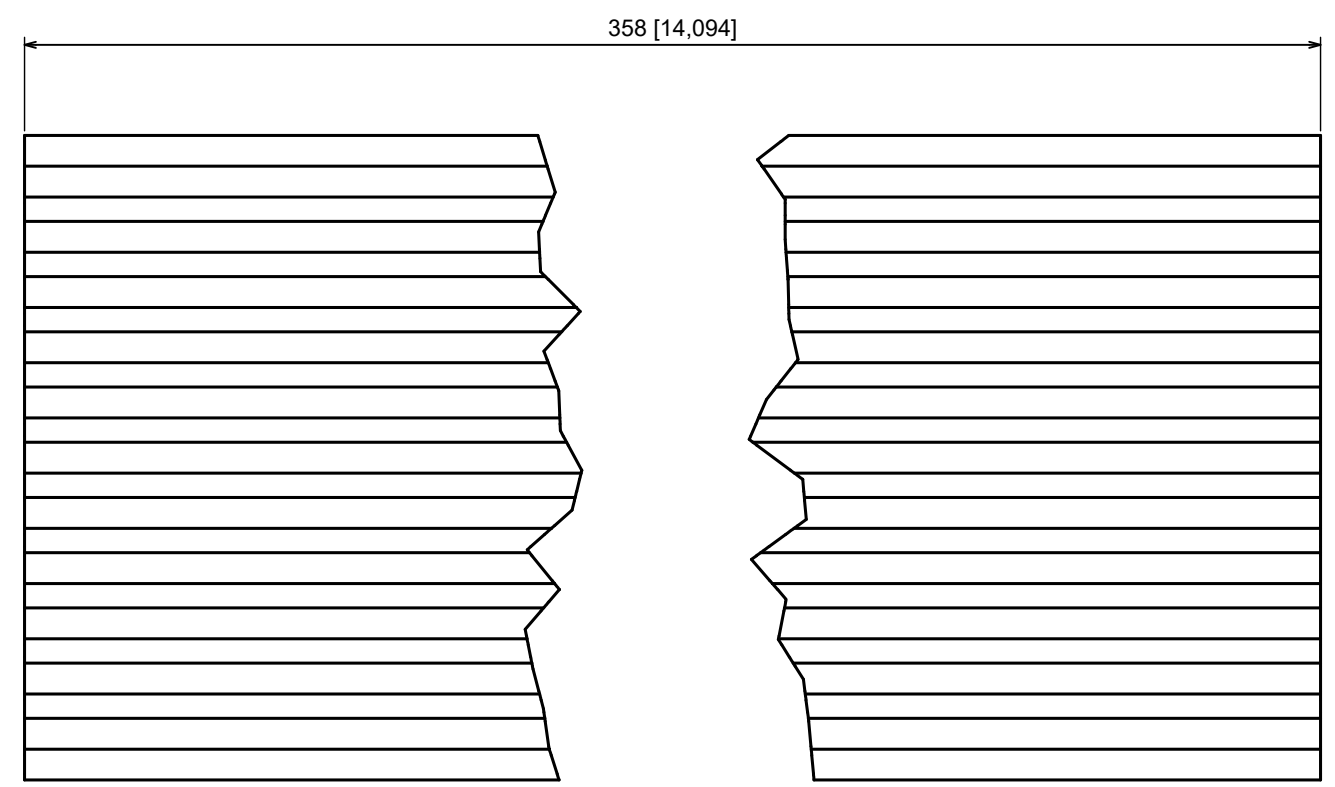
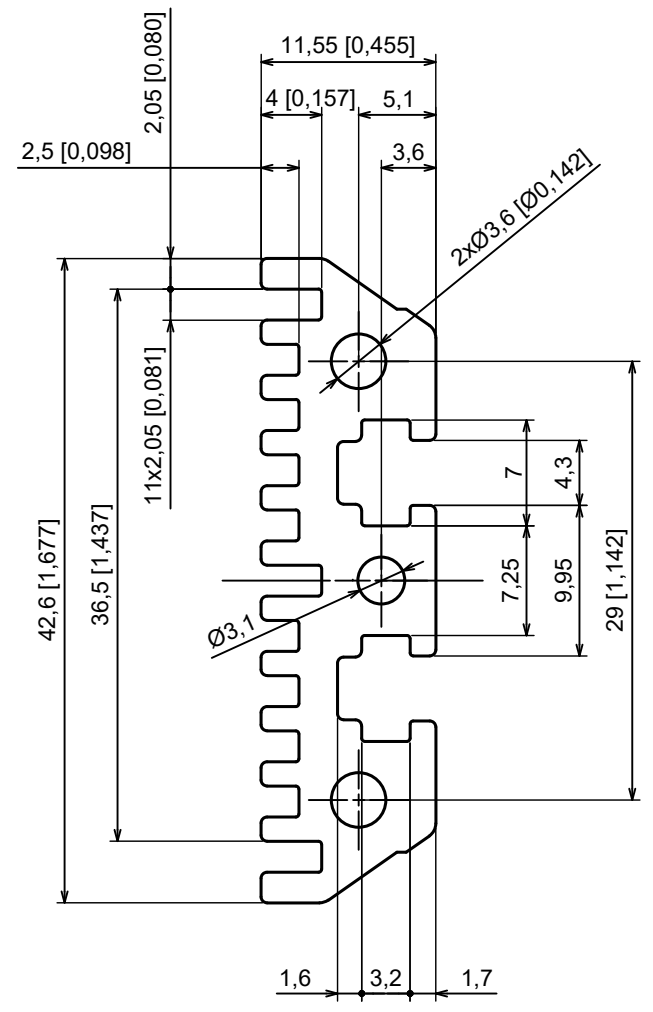

All rights reserved, Copyright Kradox 2023		
Product model	Enclosure ZR367.300.134 - Front Panel	
Format: A3	Material: Al	
Scale 1:1	Tolerance: +/- 0.5	

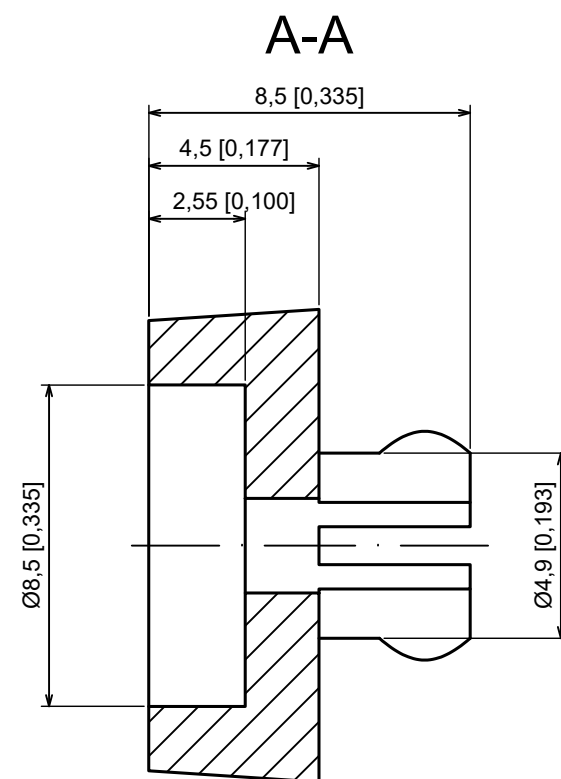
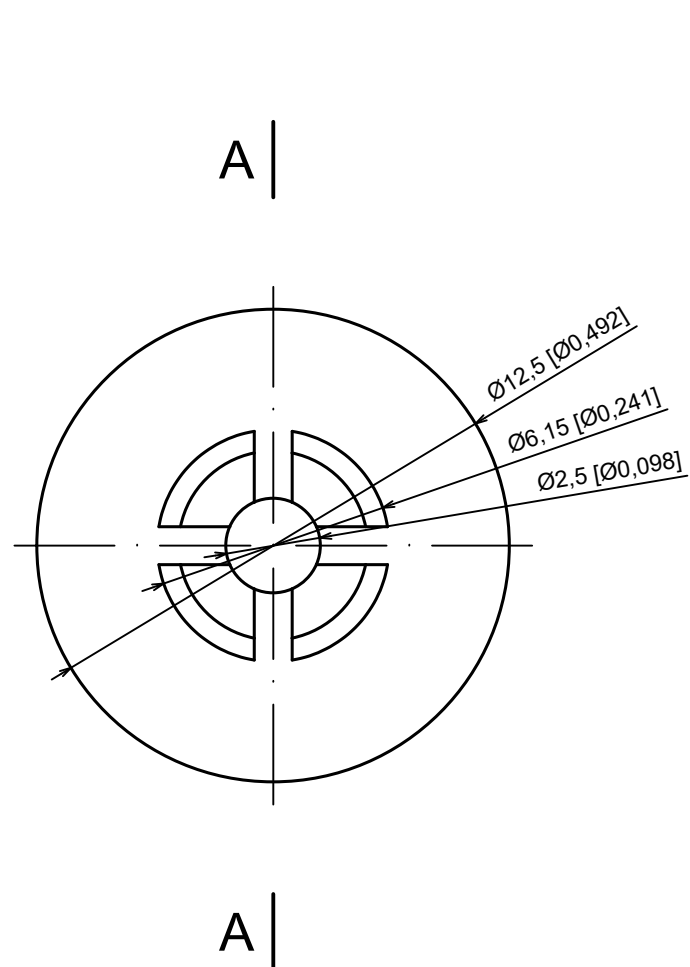

All rights reserved, Copyright Kradox 2023		
Product model	Enclosure ZR367.300.134 - Rail	
Format: A3	Material: Al	
Scale 2:1	Tolerance: +/- 0.5	



All rights reserved, Copyright Kradox 2023		
Product model	Enclosure ZR367.300.134 - Foot	
Format: A3	Material: PE	
Scale 5:1	Tolerance: +/- 0.5	

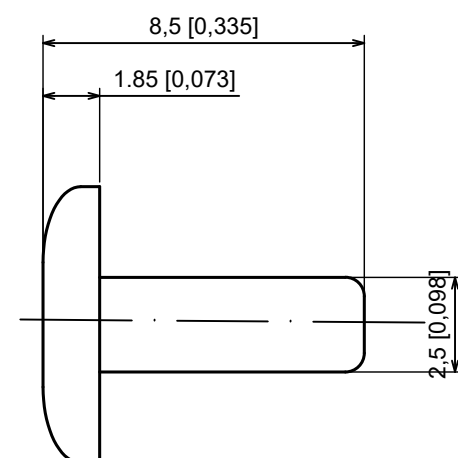
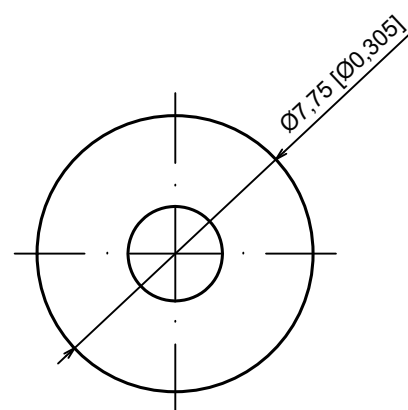

All rights reserved, Copyright Kradox 2023

Product model Enclosure ZR367.300.134 - Pin

Format: A3 Material: PP

Scale 5:1 Tolerance: +/- 0.5



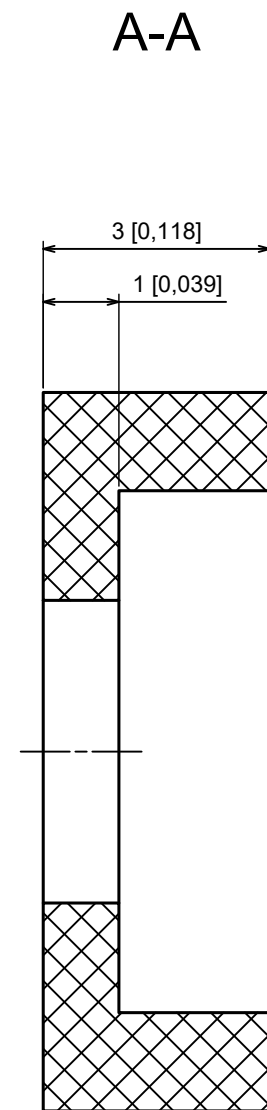
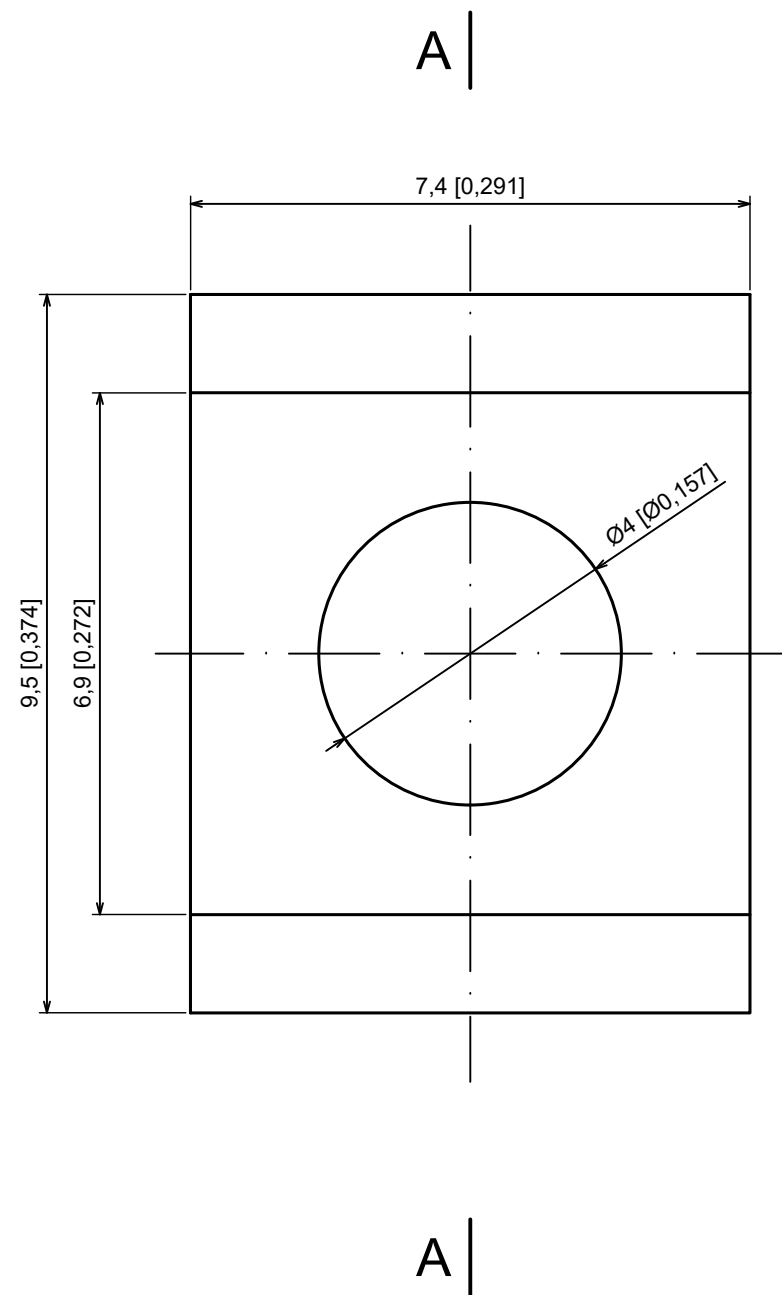

All rights reserved, Copyright Kradox 2023		
Product model	Enclosure ZR367.300.134 - Rubber Pad	
Format: A3	Material: Rubber	
Scale 10:1	Tolerance: +/- 0.5	