

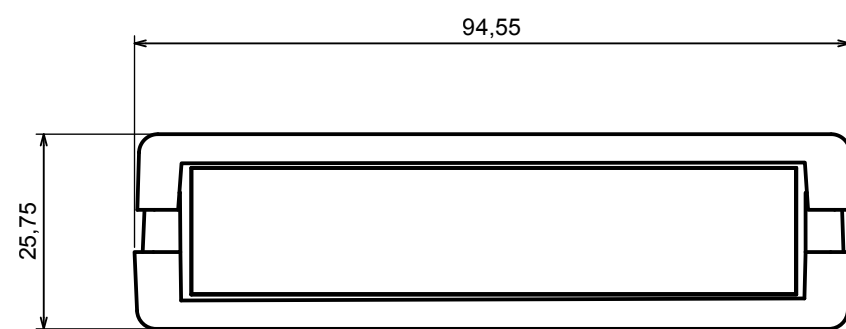

A |

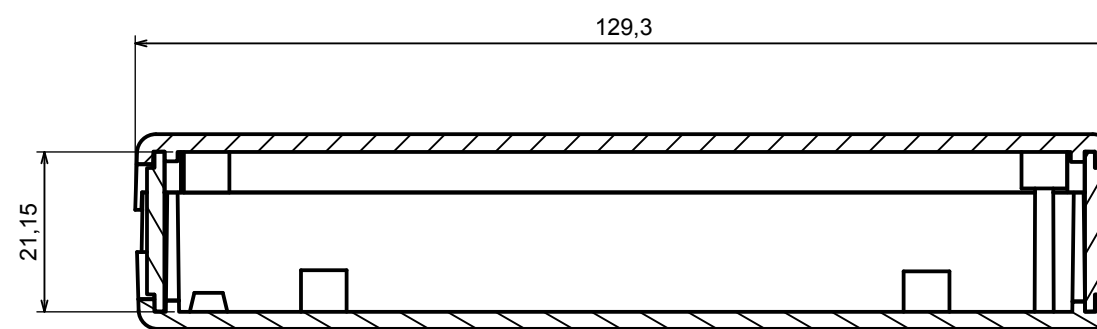

A |

A-A



All rights reserved, Copyright Kradex 2017		
Product model	Enclosure Z19 - Assembly	
Format: A3	Material: PS, ABS	
Scale 1:1	Tolerance: +/- 0.8	

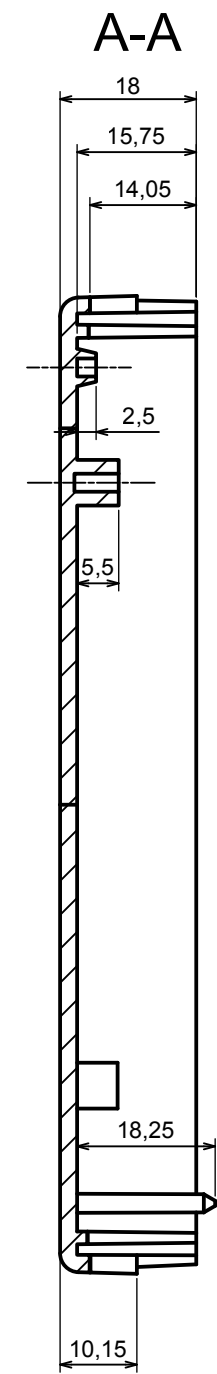
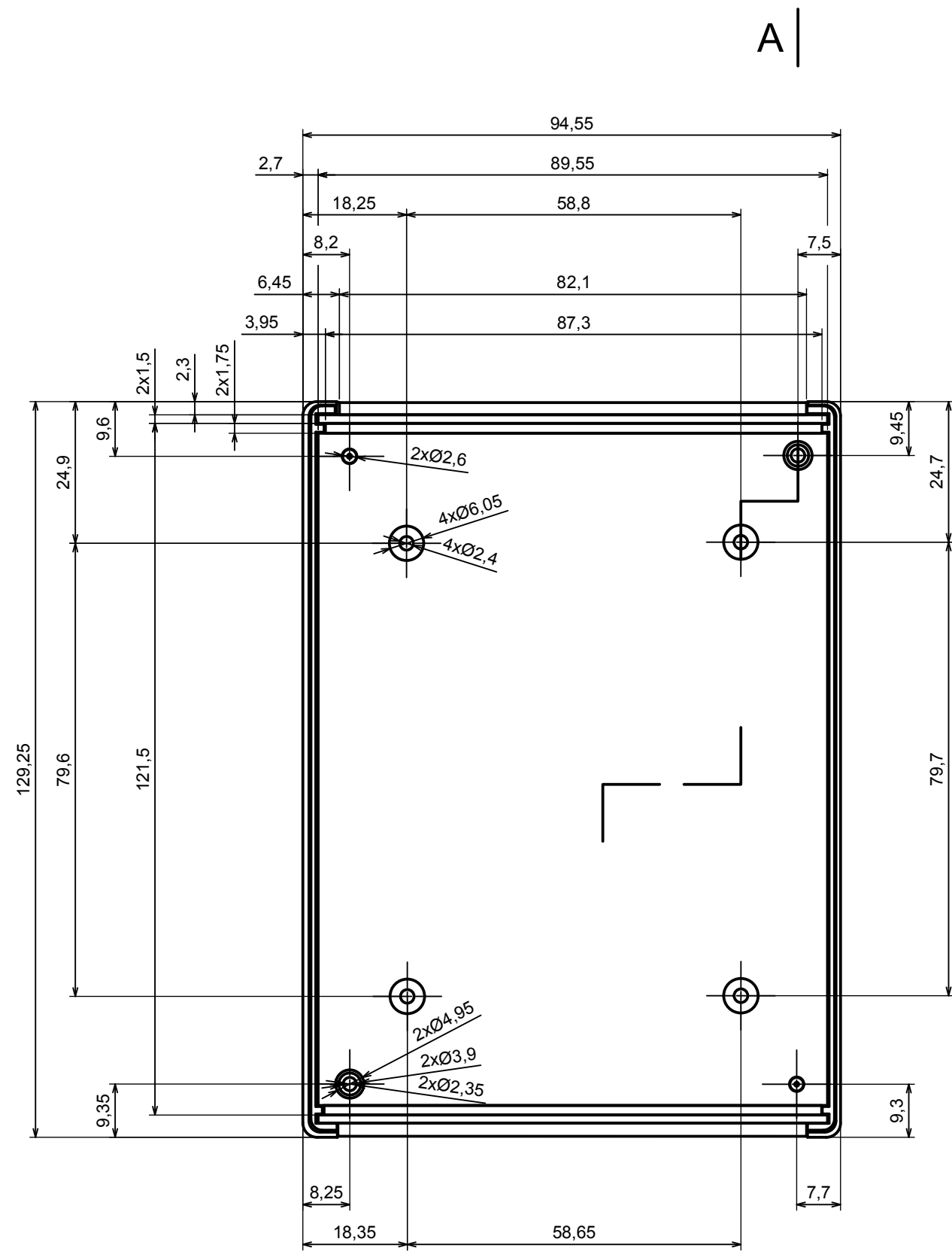

A |

All rights reserved, Copyright Kradox 2017		
Product model	Enclosure Z19 - Base	
Format: A3	Material: PS, ABS	
Scale 1:1	Tolerance: +/- 0.8	

A |

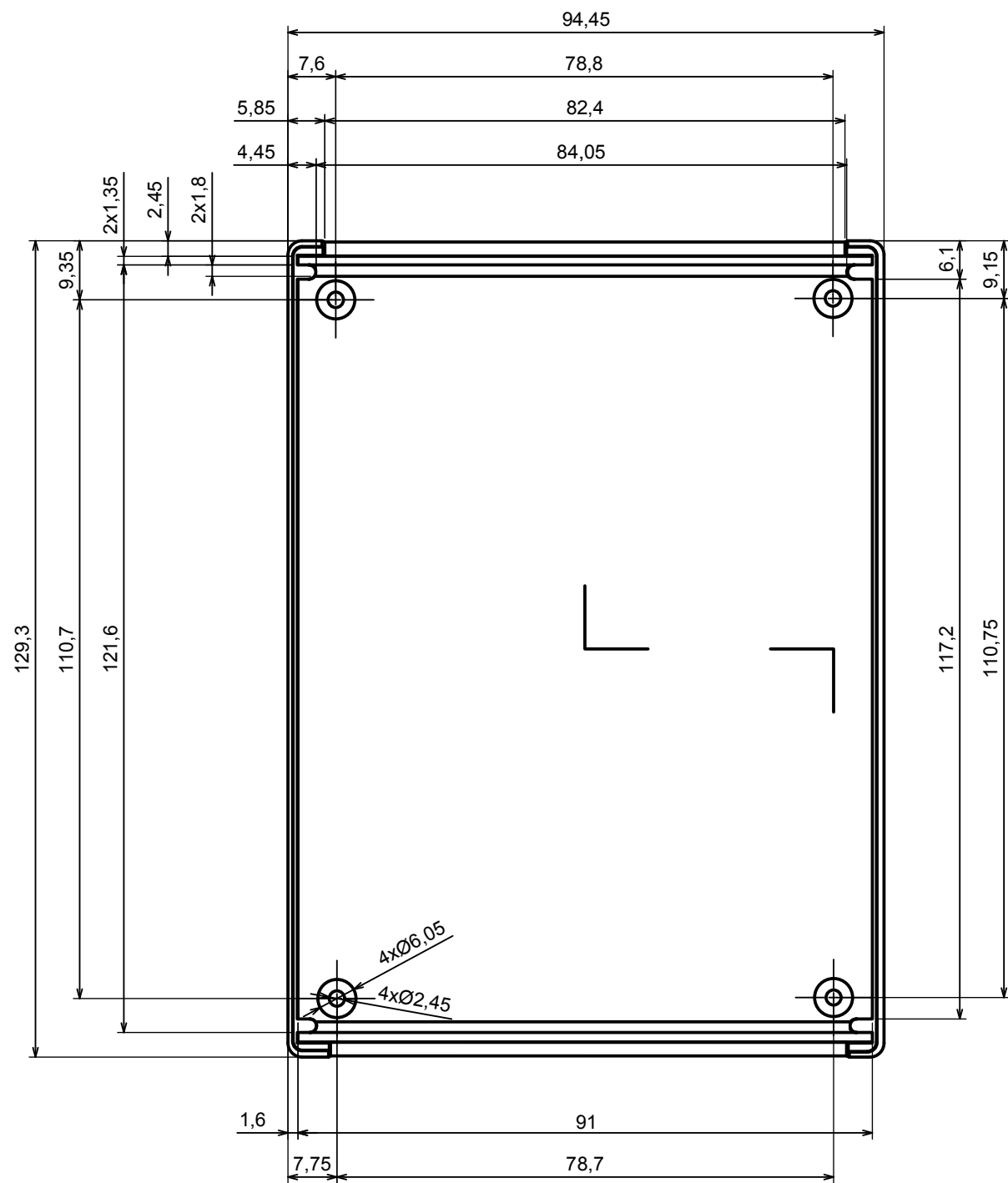

A |

A-A

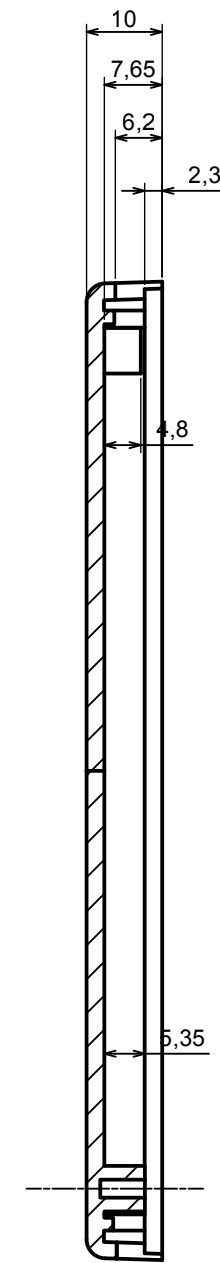

All rights reserved, Copyright Kradox 2017

Product model: Enclosure Z19 - Cover

Format: A3 Material: PS, ABS

Scale 1:1 Tolerance: +/- 0.8



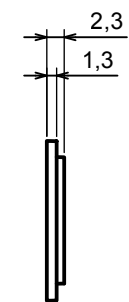
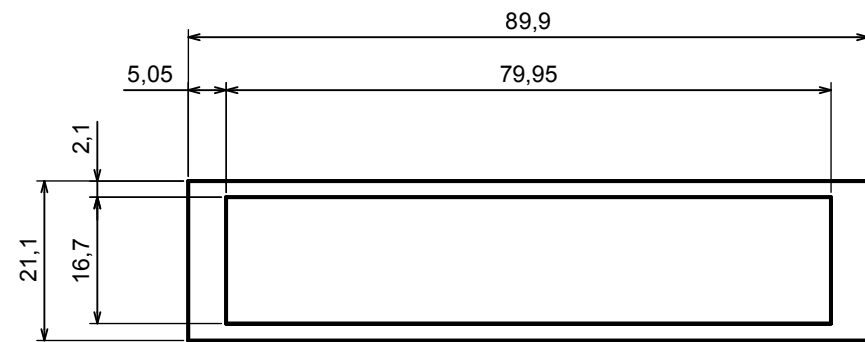

All rights reserved, Copyright Kradex 2017		
Product model	Enclosure Z19 - Board	
Format: A3	Material: PS, ABS	
Scale 1:1	Tolerance: +/- 0.8	